

Display D200

Operating instructions
Version 1.01E

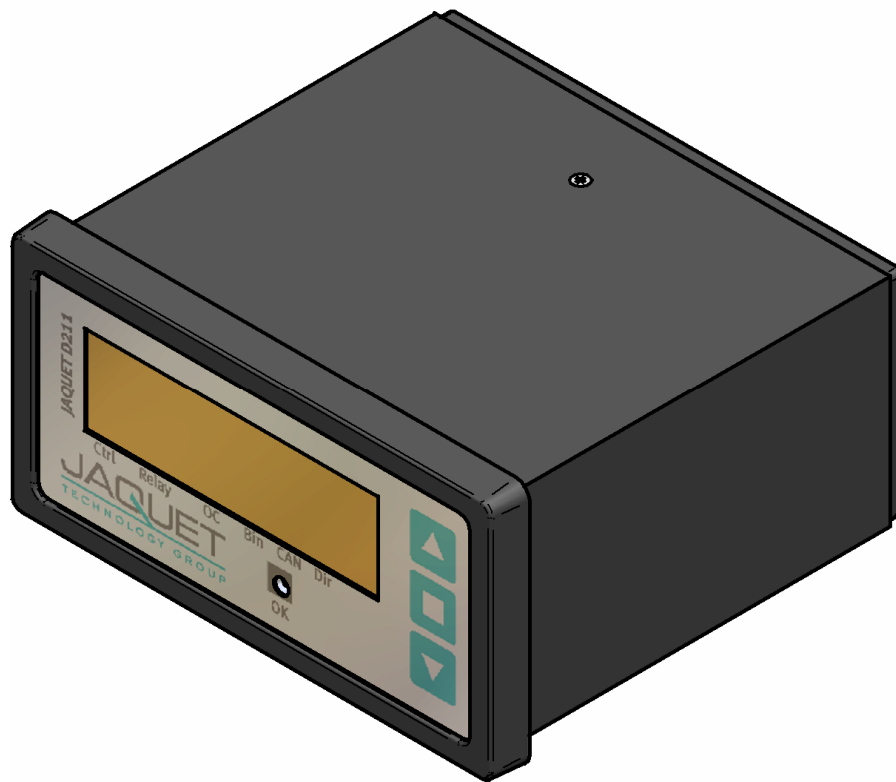

D201: Communications Module

D201: Art. Nr.: 384Z-05731, Bluetooth® Master

D211: Display

D211.10: Art. Nr.: 384Z-05729, Cable Version

D211.11: Art. Nr.: 384Z-05730, Bluetooth® Version

Contents

1	SAFETY NOTICE	4
2	PRODUCT FEATURES	5
2.1	Cable Version	5
2.2	Bluetooth® Version	5
3	SPECIFICATIONS	6
3.1	General	6
3.2	Environment	6
3.2.1	Climatic	6
3.2.2	Electromagnetic Immunity	6
3.2.3	Other Standards	6
4	PRINCIPLE OF OPERATION	7
4.1	General	7
5	INSTALLATION	8
5.1	Assembly	8
6	CONNECTIONS	10
6.1	Rear view	10
6.2	Connections - Bluetooth® version	10
6.3	Connections - Cable Version	10
7	CONFIGURATION AND OPERATION	11
7.1	Settings via PC Software	11
7.1.1	Bluetooth® Network configuration	11
7.1.2	Display Settings	12
7.2	Menu navigation	13
7.2.1	Switching the display on	13
7.2.2	Setting the display height	13
7.2.3	Contrast and brightness	13
7.2.4	Selecting process values	14
7.2.5	Status display	14
7.2.6	Factory settings	15
8	OPERATING BEHAVIOUR	16
8.1	Equipment search – reading and saving settings	16

8.2	Cable disconnection or no Bluetooth® reception	16
8.3	LED	16
8.4	Values too large or small	16
8.5	Power on behaviour	16
8.6	Display blanks for a short time	16
9	MECHANICAL CONSTRUCTION / HOUSING	17
9.1	Dimensions	17
9.2	Rear view	17
10	SHIPMENT AND ACCESSORIES	18
10.1	Cable version	18
10.2	Bluetooth® version	18
11	MAINTENANCE / REPAIR	19
12	SOFTWARE VERSION	19
13	GUARANTEE	19

1 Safety notice

D200 Series displays should only be connected by trained personnel.

D200 displays do not generate dangerous voltages but as soon as electric circuits exhibiting dangerous potentials are connected, then these may be present in the display circuits.

The display module may only be opened for repair by trained personnel.

These displays correspond to protection class I. Therefore the present PE terminal must be earthed.

The instructions in this manual must be strictly adhered.

Not following these instructions could result in damage to equipment or plant and injury to personnel as well as negating warranty claims!

Units that have suffered electrical over-load, mechanical stress or been operated outside of specification must be immediately switched off and returned to the manufacturer for repair.



2 Product features

The D200 Series allows T601 process values and status to be displayed. There are 2 models, a cable and a Bluetooth® version. With both one can:

- Display 18 different process values
- Read the status of the associated T601
- Show the process values in 2 different heights
- Adjust the contrast and brightness

The displays are configured using the T601 software. One can set:

- which process values can be selected for display
- in which format the values are shown

2.1 Cable Version

With the cable version only one display may be connected. The display is then powered by the T601.

- D211.10 Cable version: Art. Nr.: 384Z-05729

The cable to connect a display to the tachometer is Art. Nr.: 304F-73740.

2.2 Bluetooth® Version

Selecting the Bluetooth® version allows the use of up to 7 displays with one tachometer, whereby the process values to be displayed by each is freely selectable. A Bluetooth® Network is easily established using the configuration software. In the Bluetooth® version the displays must be powered.

- D211.11: Bluetooth® Version: Art. Nr.: 384Z-05730

Bluetooth® Module for T601 to display communications (no separate power required)

- D201 Bluetooth® Master: Art. Nr.: 384Z-05731

3 Specifications

3.1 General

	D211.10	D211.11		
Supply	Supply via cable connection to T601	18VDC – 36VDC		
Isolation	-	1500VDC		
Power consumption	ca. 1.25W max	Supply	P min (W)	P max (W)
		18V	0.41	1.73
		24V	0.48	1.80
		36V	0.58	1.91
Operating temperature	-20°C / +70°C	-20°C / +70°C		
Storage temperature	-20°C / +70°C	-20°C / +70°C		
Weight	190gr	210gr (excl. Bluetooth® Master)		
Protection in accordance with DIN EN 60529	IP 20			

3.2 Environment



3.2.1 Climatic

Relative Humidity	<ul style="list-style-type: none"> 75% average over the year, to 90% for max 30 days condensation to be avoided
-------------------	---

3.2.2 Electromagnetic Immunity

Electrostatic discharge	EN 61000-4-2	Contact 6 kV, Air 8 kV
Electromagnetic Fields	EN 61000-4-3	30 V/m, unmodulated and AM 80 % @ 1000 Hz Sinus wave
Fast transients	EN 61000-4-4	2kV/m, repetition rate 5 kHz, duration 15 ms, period 300 ms
Slow transients	EN 61000-4-5	Line / Line +/- 1 kV, Earth line +/- 2 kV, 1 per Minute
Conducted high frequency	EN 61000-4-6	3Vrms (130dBuV) 10 kHz – 80 MHz, AM 80 % 1000 Hz Sinus wave, Power Cable
Power frequency Magnetic fields	EN 61000-4-8	50 Hz, 100 A/m 2 Minutes
Voltage dips	EN 61000-4-11	Voltage dips, short interruptions and voltage variations immunity tests

3.2.3 Other Standards

	Germanischer Lloyd – in progress
	Communauté Européenne – in progress

4 Principle of operation

4.1 General

The tachometer periodically sends all process values and status to the associated D200. The available parameters for display are those selected in the configuration software. All status information is always shown.

18 different process values are available for display. These are selected for display using the front panel Up / Down buttons. Process values may be displayed in one of two different heights. In the Bluetooth® version one process value can be shown per display.

The status of binary inputs, relay outputs and open collector outputs and tachometer functions is also shown.

5 Installation

D200 Series displays should only be installed by trained personnel. Undamaged equipment, proper configuration and installation are prerequisites for correct operation. Please observe the safety notice in section 1.

Where powered separately from the T601, the supply to a D200 display should be via a switch enabling supply isolation in emergencies.

These displays correspond to protection class I. Therefore the present PE terminal must be earthed.

Before switching on, make sure that the supply is within specified limits.

5.1 Assembly

The T601 must be switched off before plugging in the cable or Bluetooth® Master. After this the display cable or the Bluetooth® Master may be plugged in.

Cable version

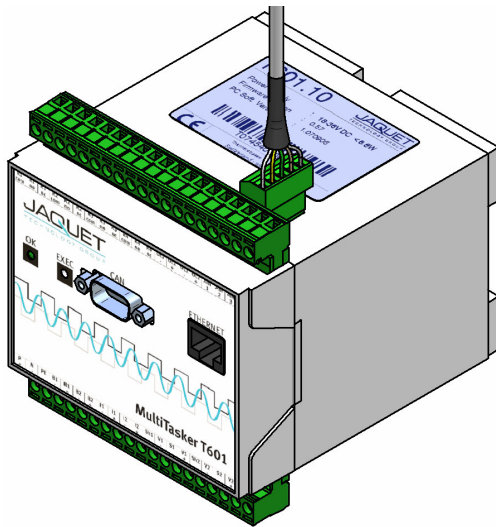

Bluetooth® version

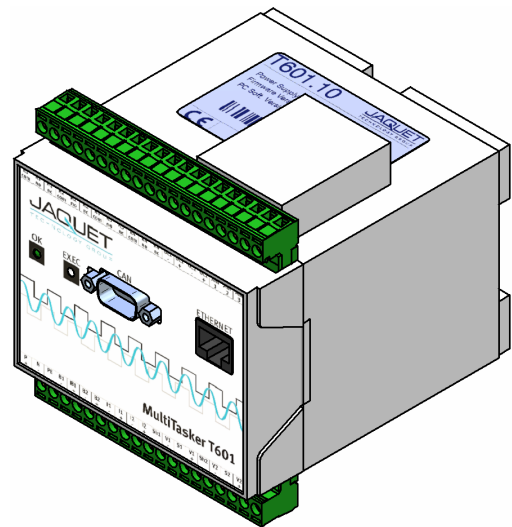

Once the cable is plugged into the T601 it can be plugged into the display. After powering on it will communicate with the tachometer.

If the Bluetooth® Master is plugged in, the display power may be switched on. The display will run, be integrated into the Bluetooth® Network and can be configured using the configuration software.

Cable version

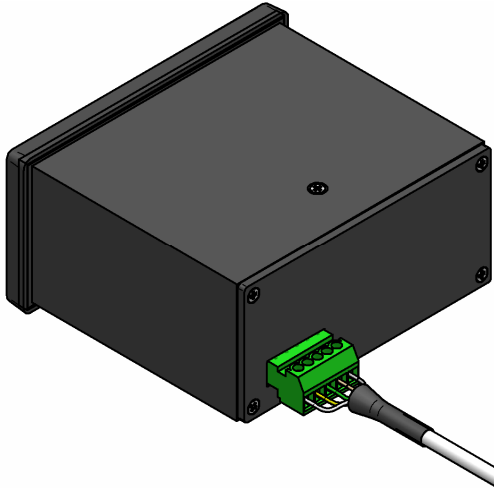

Bluetooth® version

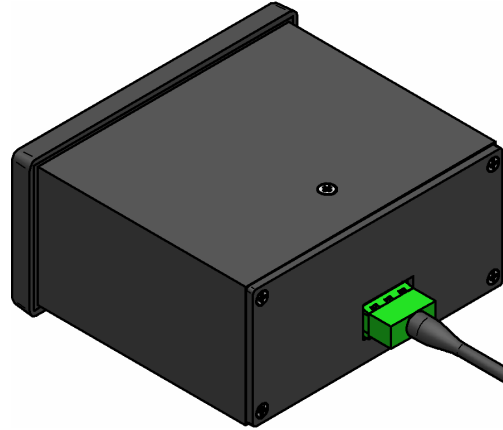

6 Connections

6.1 Rear view

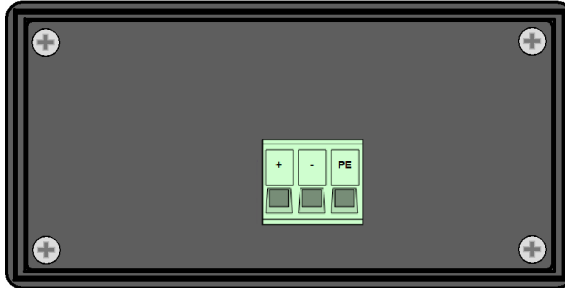

D211.11 (Bluetooth®)



D211.10 (Cable version)

6.2 Connections - Bluetooth® version

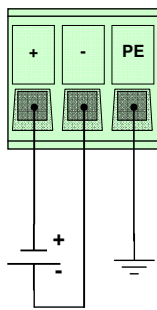

Speisung
(Rear view D211)

Supply

- + : Supply +ve
- : Supply -ve
- PE : Earth

6.3 Connections - Cable Version

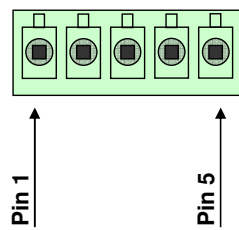

(Rear view D211)

- Pin 1 : Supply +ve
- Pin 2 : Ground
- Pin 3 : Rx
- Pin 4 : Tx
- Pin 5 : NC (Screen)

7 Configuration and operation

7.1 Settings via PC Software

Display settings are made using a PC, crossover Ethernet cable connected to the T601 and the resident T601 configuration software.

To run the software you must have Java Runtime Environment (JRE) 1.5 or higher.

Factory settings are shown in **bold** in the following.

7.1.1 Bluetooth® Network configuration

Go to <Settings>, <Bluetooth settings>.

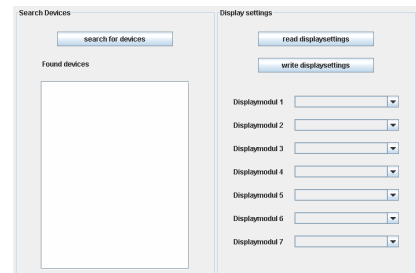
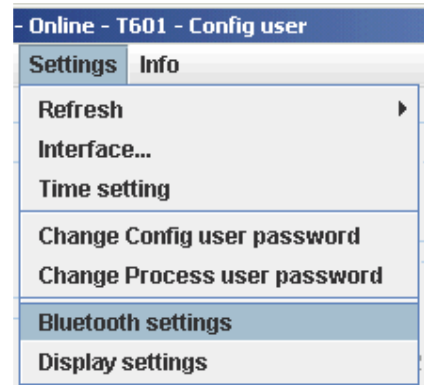

If you have not yet connected a Bluetooth® Display or wish to connect an additional display, click on <search for devices>. Searching may take several seconds. Equipment found will be shown in the list (all Bluetooth® equipment found will be shown).



To assign displays to the tachometer select those required from the selection menus on the right.

After assigning the displays, save the settings via <Save settings>. This process can take a few seconds.

NB: These settings are independent of the other parameters and are not transferred with Read / Write parameters.

To read the current settings click on <read display settings> and the actual settings will be shown. This may take a few seconds.



7.1.2 Display Settings

To configure the display go to <Settings>, <Display settings>.

18 tachometer process values are available for display.

In each case one can select whether the value is available for display and in which format it will be shown.

By selecting "Autorange", the decimal point is floating. Alternatively the decimal point may be fixed in one location, or for values > 100,000, the display format 100.0k is available.

Is the process value available for display? **Yes / No**

Display format	automatic /
	0000.0 /
	000.00 /
	00.000 /
	0.0000 /
	100.0k

If Variance is to be displayed, the measurement time must be >= 5ms.

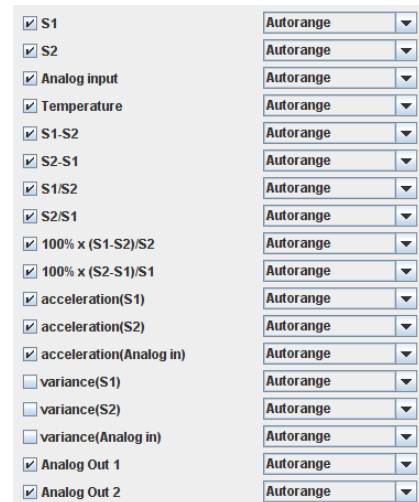
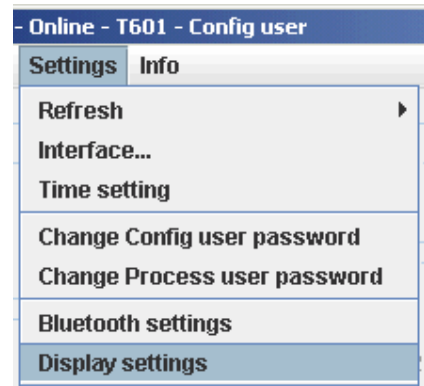

7.2 Menu navigation

3 push buttons are provided for menu navigation.

- ▲ Up button
- □ Extended Menu button
- ▼ Down button

7.2.1 Switching the display on

Once the display is powered it will show the message “IN CHARGE OF SPEED“ for a few seconds and underneath the display’s software revision level.

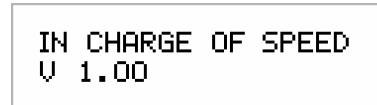

Thereafter the display will go out, the connection to the tachometer will be established and in the bottom right hand corner x and + will alternate to show that the display is operational.



7.2.2 Setting the display height

Process values may be displayed in one of 2 ways:

- Large display of just the process values.
- Display of process values, units and tachometer status.

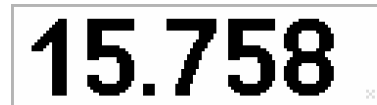

To switch between the 2, press the extended menu button (□) for two seconds. A black square will appear on the right and one can then use the Up (▲) and Down (▼) buttons to select the chosen units. The settings are immediately saved.



7.2.3 Contrast and brightness

Contrast and brightness may be set manually.

After pressing the Extended Menu button (□) for 2 seconds one comes to the size setting. By pressing the button again one reaches the contrast menu and the contrast symbol appears on the right. Up (▲) and Down (▼) buttons allow the contrast to be set. The setting is immediately saved.



Pressing the Extended Menu button (□) again brings you to the brightness menu. Up (▲) and Down (▼) buttons allow the brightness to be set. The setting is immediately saved.



Press the button again and you are brought back to the normal display. If not pressed again the display will automatically save the settings and return to normal mode after 5 seconds.

7.2.4 Selecting process values

Select the process values to be displayed using the Up (▲) and Down (▼) buttons. 18 different values are available for display:

- S1
- S2
- Analogue input
- Temperature
- S1 – S2
- S2 – S1
- S1 / S2
- S2 / S1
- 100% x (S1-S2) / S1
- 100% x (S2-S1) / S2
- Acceleration (S1)
- Acceleration (S2)
- Acceleration (Analogue input)
- Variance (S1)
- Variance (S2)
- Variance (Analogue input)
- Analogue output 1
- Analogue output 2



Whether a process value can be displayed is defined in the configuration software.

7.2.5 Status display

If the small display mode is selected, then the tachometer status line always appears. They are not selectable by configuration and are always visible.



7.2.5.1 Parameter set

The character on the left shows the tachometer's active parameter set, labelled <Ctrl>. On the front panel the location is indicated with <Ctrl>.



7.2.5.2 Relays

Relay status is shown as energised (●) or de-energised (○) and labelled <Relay>. On the front panel the location is indicated with <Relay>.



7.2.5.3 Open Collectors

The Open Collector status is labelled <OC> and shown as energised (●) or de-energised (○), or with (x) if used as a frequency output. On the front panel the location is indicated with <OC>.



7.2.5.4 Binary inputs

Binary input status is labelled <Bin> and shown as active (●) or inactive (○). On the front panel the location is indicated with <Bin>.



7.2.5.5 CAN

The CAN bus input is labelled <CAN> and is shown as activated (●) or deactivated (○). On the front panel the location is indicated with <CAN>.



7.2.5.6 Direction of rotation

The detected direction of rotation is labelled <Dir>, with arrow right signifying clockwise rotation as defined in the configuration software and arrow left meaning counter clockwise rotation.

If <no Creep> is detected a square box appears.

On the front panel the location is indicated with <Dir>.



7.2.5.7 Bluetooth® reception

The Bluetooth® reception quality is shown on the right, whereby 4 bars mean acceptable reception. If all 4 bars are not present no connection exists.



7.2.6 Factory settings

The display can be returned to factory settings by pressing the Extended Menu button (□) for 8 seconds.

8 Operating behaviour

8.1 Equipment search – reading and saving settings

The display behaves as follows during equipment search, reading or saving settings:

- the LED goes out
- the Process value selection and corresponding units are visible
- cross (x) and plus (+) signs alternate



8.2 Cable disconnection or no Bluetooth® reception

If no data connection exists between display and the tachometer it behaves as follows:

- The LED goes out
- the process value selection and corresponding units are visible
- cross (x) and plus (+) signs alternate
- if in the case of the cable version power is lost then the whole display goes out.

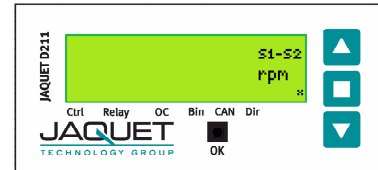

8.3 LED

The display LED can assume one of 3 states:

- LED off: See 8.1 and 8.2.
- LED on: No fault present
- LED flashing: Data transfer in progress

8.4 Values too large or small

If values are too large or small for the display mode selected, the display stops on maximum or minimum. (Picture right: Minimum value shortfall <0.0k)

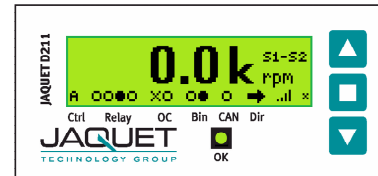

8.5 Power on behaviour

When first powered, <IN CHARGE OF SPEED> appears for 5 seconds and underneath a text line showing the display's software version. This text then goes out and the process values are shown.

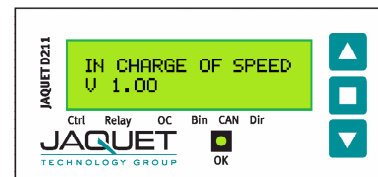

8.6 Display blanks for a short time

If not all registered displays are operational, other displays may blank out for a short period of time. Remove the displays that are not in operation.



9 Mechanical construction / Housing

9.1 Dimensions

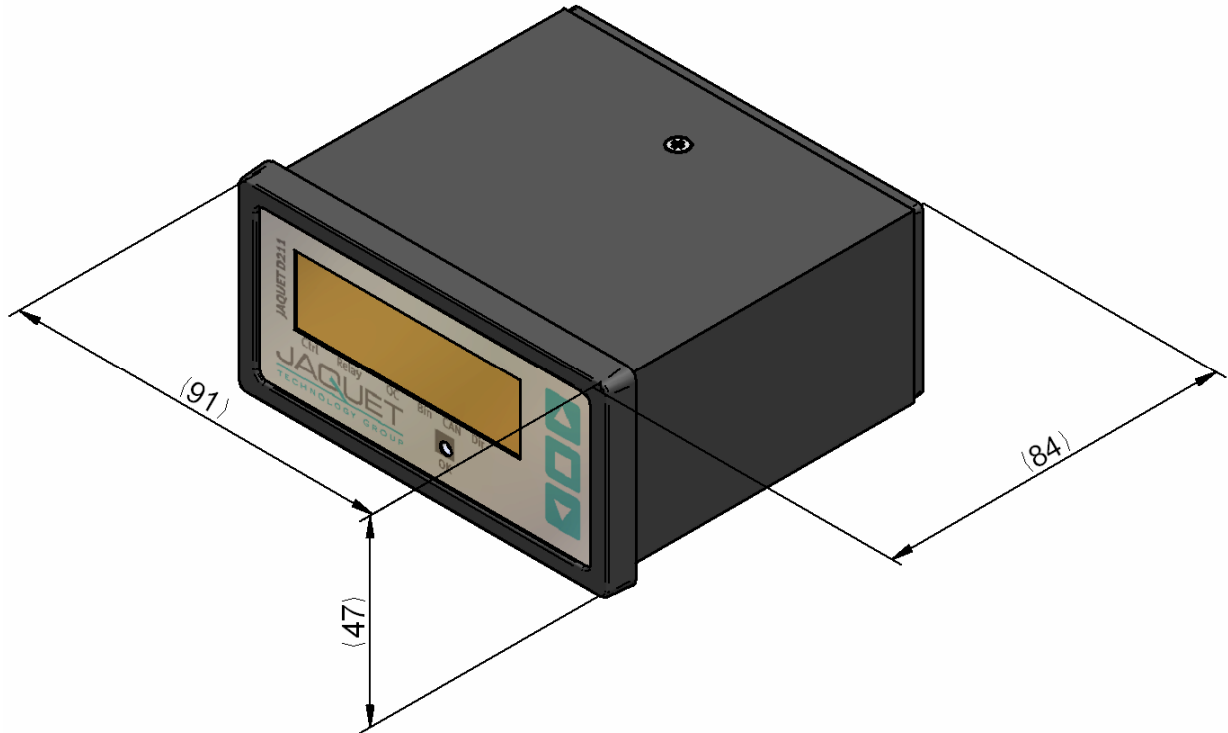

All dimensions in millimetres (mm)

9.2 Rear view

Cable Version



Bluetooth® Version

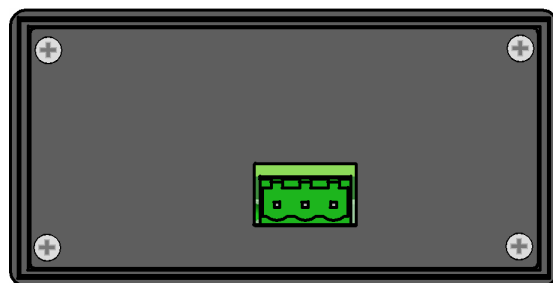

10 Shipment and accessories

10.1 Cable version

Cable with connectors for self assembly

- D211.10 Cable Version: Article Nr. 384Z-05729
(The cable 304F-73740 is included in delivery)
- Cable with connectors: Article Nr. 304F-73740

10.2 Bluetooth® version

Up to 7 Bluetooth® displays may be connected using one base module. The displays have the Bluetooth® receiver in the unit.

- D201 Display Base Module: Article Nr. 384Z-05731
- D211.11 Bluetooth® Version: Article Nr. 384Z-05730

11 Maintenance / Repair

D200 Series displays require no maintenance as no batteries or other consumable items are included.

If cleaning the instruments please take note of the protection level.

As far as possible, the display should be isolated from the supply and any other potential power sources e.g. relay voltages. To clean the surface use spirit, pure alcohol or soap.

12 Software version

Software Version	Changes
1.00	First edit
1.01	New graphics introduced.

13 Guarantee

The standard warranty in the event of a manufacturing defect confirmed by JAQUET consists of repair or replacement within 12 months of delivery.

Travel and labour costs are excluded from warranty as well as damages caused by abnormal use outside the specifications.

Complaints concerning visible defects will only be accepted if advised to JAQUET within 14 days of receipt.